



■ Vers. L12



■ Vers. L12







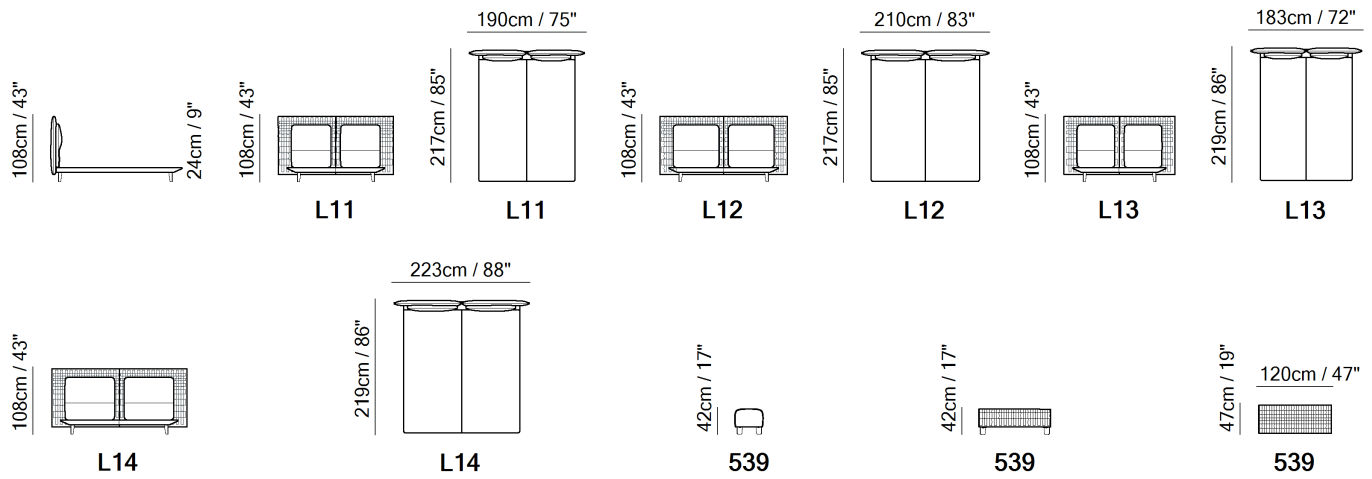

■ Vers. L12+539

## SCHEMATICS



TECHNICAL INFORMATION

	<b>COVERING</b>	Leather <input checked="" type="checkbox"/>	Soft Cover <input checked="" type="checkbox"/>			
	<b>LEGS</b>	Wood <input type="checkbox"/>	Plastic <input type="checkbox"/>	Metal <input type="checkbox"/>	Upholstered <input type="checkbox"/>	Castors <input type="checkbox"/>
	<b>FILLING</b>	Arms	<input type="checkbox"/> Fiber <input type="checkbox"/> Foam <input type="checkbox"/> Feather/Fiber Mix <input type="checkbox"/> Feather	Seat cushion	<input type="checkbox"/> Fiber <input type="checkbox"/> Foam <input type="checkbox"/> Feather/Fiber Mix <input type="checkbox"/> Feather	Back cushion <input type="checkbox"/> Fiber <input type="checkbox"/> Foam <input type="checkbox"/> Feather/Fiber Mix <input type="checkbox"/> Feather
	<b>COMFORT</b>	Standard Comfort <input checked="" type="checkbox"/>	Firm Comfort <input type="checkbox"/>			
	<b>FUNCTION</b>	Bed <input type="checkbox"/>	Electric motion <input type="checkbox"/>	Motion <input type="checkbox"/>	Recliner <input type="checkbox"/>	Sliding <input type="checkbox"/>
	<b>OPTIONS</b>	Nails <input type="checkbox"/>	Contrast Stitching <input type="checkbox"/>	Removable <input type="checkbox"/>		
	<b>WRINKLES &amp; VISUAL APPEARANCE</b>	Low <input type="checkbox"/>	Medium <input checked="" type="checkbox"/>	High <input type="checkbox"/>		

WRINKLES & VISUAL APPEARANCE

The product may reveal various wrinkles due to the combination of Elasticity of the covering, characteristics of the interior construction and the design of the product.

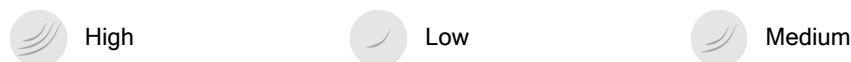

Products with Visual Appearance listed as High or Medium would require higher degree of care, where seats and back cushions may require fluffing and plumping more often than Products with Visual Appearance listed as Low.

NOTES

- Designed by Mauro Lipparini.
- In leather the model is available starting from cat. 15.
- The headboard is also covered on the back to allow the positioning of the bed even in the middle of the room.
- L025 available with Gargano woven leather to order as second cover. The first cover is associated with cushions that can be upholstered in leather or fabric. These cushions are removable
- LR25 without weave and available in leather or fabric (single cover)
- Available in 4 sizes: 160x200-180x200-153x200-193X200 cm. More sizes to meet every need of space and possibility to cover the bed with the wide range of Natuzzi Italia coverings.
- Powder coated feet available in the same finishes of the sofa or ft 46 champagne or ft 79 matt black

**NOTES**

---



■ Vers. L11



■ Vers. L11







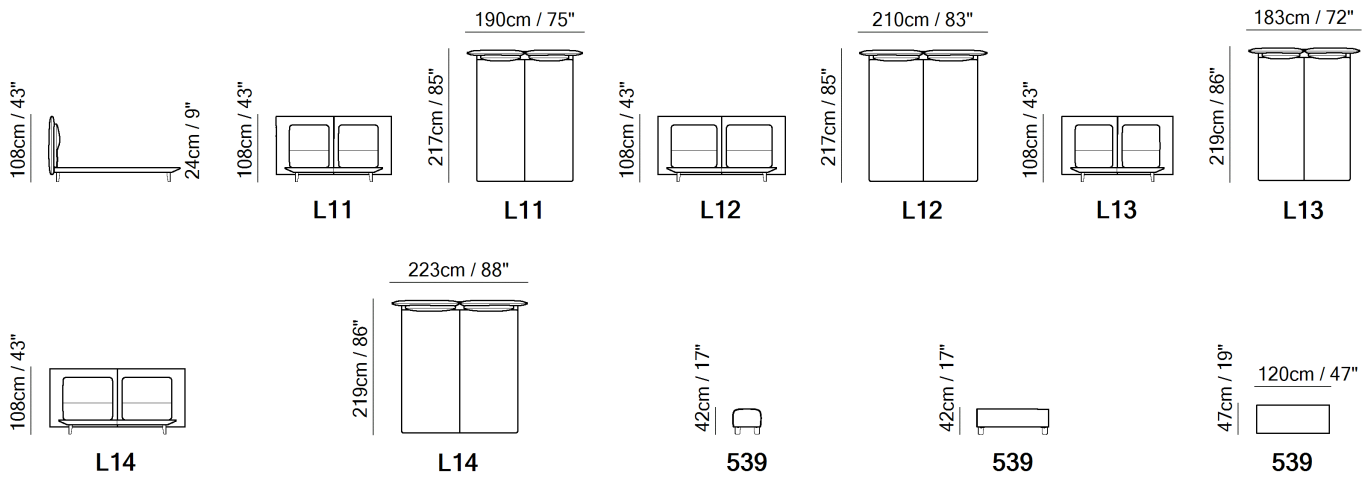

■ Vers. L11

**SCHEMATICS**



TECHNICAL INFORMATION

	<b>COVERING</b>	Leather <input checked="" type="checkbox"/>	Soft Cover <input checked="" type="checkbox"/>			
	<b>LEGS</b>	Wood <input type="checkbox"/>	Plastic <input type="checkbox"/>	Metal <input type="checkbox"/>	Upholstered <input type="checkbox"/>	Castors <input type="checkbox"/>
	<b>FILLING</b>	Arms <input type="checkbox"/> Fiber <input type="checkbox"/> Foam <input type="checkbox"/> Feather/Fiber Mix <input type="checkbox"/> Feather	Seat cushion <input type="checkbox"/> Fiber <input type="checkbox"/> Foam <input type="checkbox"/> Feather/Fiber Mix <input type="checkbox"/> Feather	Back cushion <input type="checkbox"/> Fiber <input type="checkbox"/> Foam <input type="checkbox"/> Feather/Fiber Mix <input type="checkbox"/> Feather		
	<b>COMFORT</b>	Standard Comfort <input checked="" type="checkbox"/>	Firm Comfort <input type="checkbox"/>			
	<b>FUNCTION</b>	Bed <input type="checkbox"/>	Electric motion <input type="checkbox"/>	Motion <input type="checkbox"/>	Recliner <input type="checkbox"/>	Sliding <input type="checkbox"/>
	<b>OPTIONS</b>	Nails <input type="checkbox"/>	Contrast Stitching <input type="checkbox"/>	Removable <input type="checkbox"/>		
	<b>WRINKLES &amp; VISUAL APPEARANCE</b>	Low <input type="checkbox"/>	Medium <input checked="" type="checkbox"/>	High <input type="checkbox"/>		

WRINKLES & VISUAL APPEARANCE

The product may reveal various wrinkles due to the combination of Elasticity of the covering, characteristics of the interior construction and the design of the product.



Products with Visual Appearance listed as High or Medium would require higher degree of care, where seats and back cushions may require fluffing and plumping more often than Products with Visual Appearance listed as Low.

NOTES

- Designed by Mauro Lipparini.
- LR25 without weave and available in leather or fabric (single cover)
- L025 available with Gargano woven leather to order as second cover. The first cover is associated with cushions that can be upholstered in leather or fabric. These cushions are removable
- In leather the model is available starting from cat. 15.
- The headboard is also covered on the back to allow the positioning of the bed even in the middle of the room.
- Available in 4 sizes: 160x200-180x200-153x200-193X200 cm. More sizes to meet every need of space and possibility to cover the bed with the wide range of Natuzzi Italia coverings.
- Powder coated feet available in the same finishes of the sofa or ft 46 champagne or ft 79 matt black

NOTES

---